

Power MOSFET 200 mAmps, 50 Volts N-Channel SOT-23

1. FEATURES

- We declare that the material of product compliance with RoHS requirements and Halogen Free.
- S- prefix for automotive and other applications requiring unique site and control change requirements; AEC-Q101 qualified and PPAP capable.
- Low threshold voltage ($V_{GS(th)}$: 0.5V...1.5V) makes it ideal for low voltage applications.

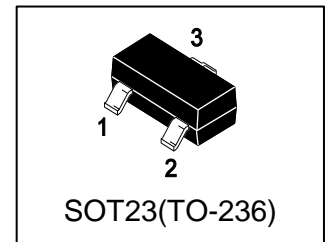

2. DEVICE MARKING AND ORDERING INFORMATION

Device	Marking	Shipping
LBSS138LT1G	J1	3000/Tape&Reel
LBSS138LT3G	J1	10000/Tape&Reel

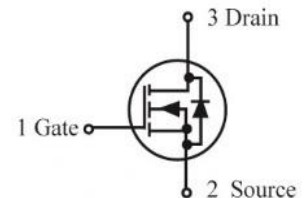

3. MAXIMUM RATINGS($T_a = 25^\circ\text{C}$)

Parameter	Symbol	Limits	Unit
Drain-Source Voltage	VDSS	50	Vdc
Gate-to-Source Voltage – Continuous	VGS	± 20	Vdc
Drain Current			mAdc
– Continuous $T_A = 25^\circ\text{C}$	ID	200	
– Pulsed ($t_p \leq 10\mu\text{s}$)	IDM	800	

4. THERMAL CHARACTERISTICS

Parameter	Symbol	Limits	Unit
Total Device Dissipation, FR-5 Board (Note 1) @ $T_A = 25^\circ\text{C}$ Derate above 25°C	PD	225	mW
		1.8	mW/ $^\circ\text{C}$
Thermal Resistance, Junction-to-Ambient(Note 1)	R θ JA	556	$^\circ\text{C}/\text{W}$
Junction and Storage temperature	T $_J$, T $_{stg}$	$-55 \sim +150$	$^\circ\text{C}$
Maximum Lead Temperature for Solde Purposes, for 10 seconds	TL	260	$^\circ\text{C}$

1. FR-5 = 1.0×0.75×0.062 in.

5. ELECTRICAL CHARACTERISTICS (Ta= 25°C)

OFF CHARACTERISTICS

Characteristic	Symbol	Min.	Typ.	Max.	Unit
Drain–Source Breakdown Voltage (VGS = 0, ID = 250 μ A _{dc})	VBRDSS	50	-	-	V _{dc}
Zero Gate Voltage Drain Current (VGS = 0, VDS = 25 V _{dc}) (VGS = 0, VDS = 50 V _{dc})	IDSS	- -	- -	0.1 0.5	μ A _{dc}
Gate–Body Leakage Current, Forward (VGS = 20 V _{dc})	IGSSF	-	-	0.1	μ A _{dc}
Gate–Body Leakage Current, Reverse (VGS = - 20 V _{dc})	IGSSR	-	-	-0.1	μ A _{dc}

ON CHARACTERISTICS (Note 2)

Gate Threshold Voltage (VDS = VGS, ID = 1.0mA _{dc})	VGS(th)	0.5	-	1.5	V _{dc}
Static Drain–Source On–State Resistance (VGS = 2.75 V _{dc} , ID < 200 mA _{dc} , TA = –40°C to +85°C) (VGS = 5.0 V _{dc} , ID = 200 mA _{dc})	RDS(on)	- -	5.6 -	10 3.5	Ohms
Forward Transconductance (VDS = 25 V _{dc} , ID = 200 mA _{dc} , f = 1.0 kHz)	gfs	100	-	-	mS

DYNAMIC CHARACTERISTICS

Input Capacitance (VDS = 25 V _{dc} , VGS = 0, f = 1.0 MHz)	Ciss	-	40	50	pF
Output Capacitance (VDS = 25 V _{dc} , VGS = 0, f = 1.0 MHz)	Coss	-	12	25	pF
Reverse Transfer Capacitance (VDS = 25 V _{dc} , VGS = 0, f = 1.0 MHz)	Ciss	-	3.5	5.0	pF

SWITCHING CHARACTERISTICS

Turn-On Delay Time	(VDD = 30 V _{dc} , ID =200 mA _{dc})	td(on)	-	-	20	ns
Turn-Off Delay Time		td(off)	-	-	20	

2.Pulse Test: Pulse Width \leq 300 μ s, Duty Cycle \leq 2.0%.

6. ELECTRICAL CHARACTERISTICS CURVES

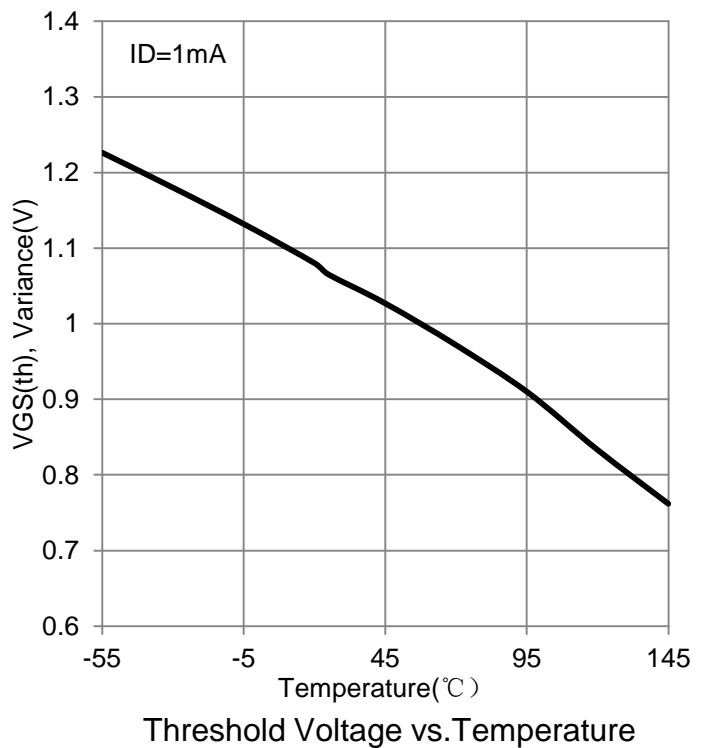
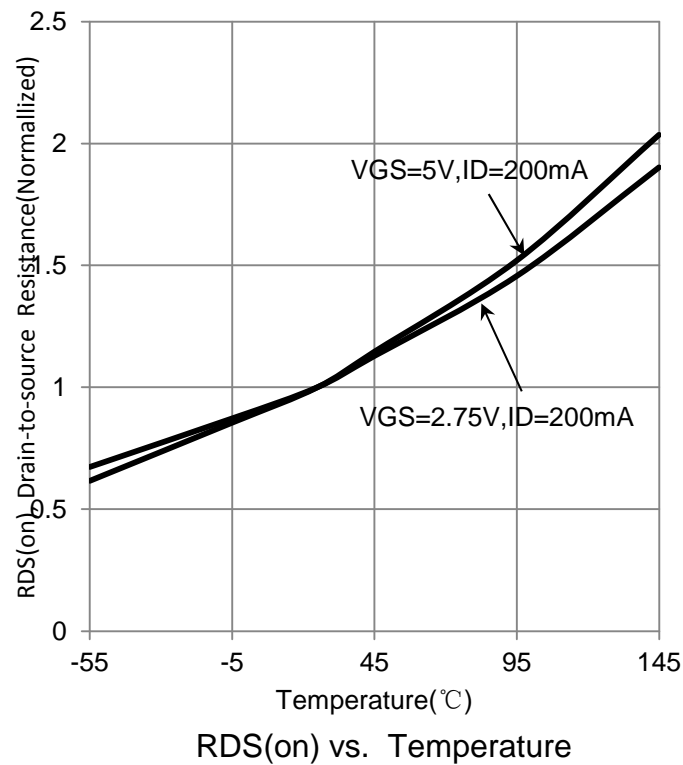
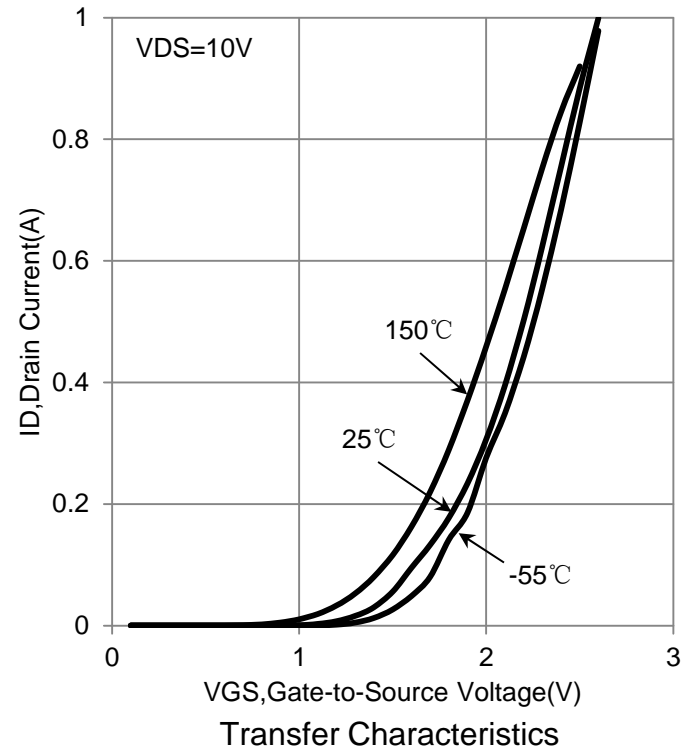
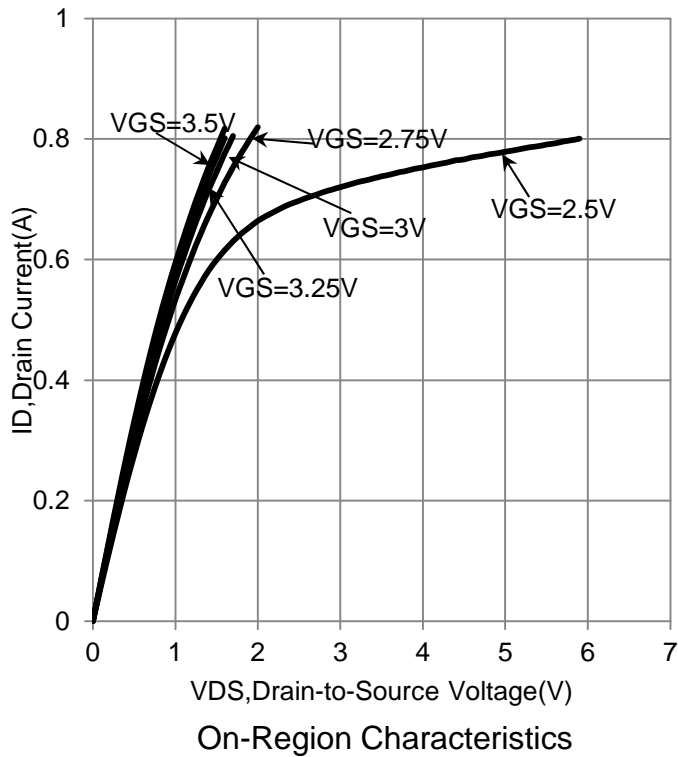

6.ELECTRICAL CHARACTERISTICS CURVES(Con.)

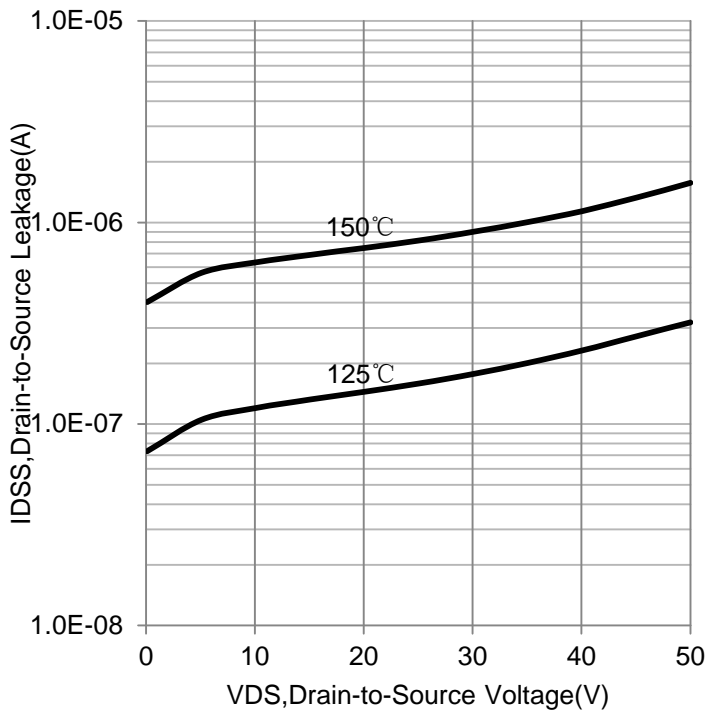

I_{DSS} vs. V_{DS}

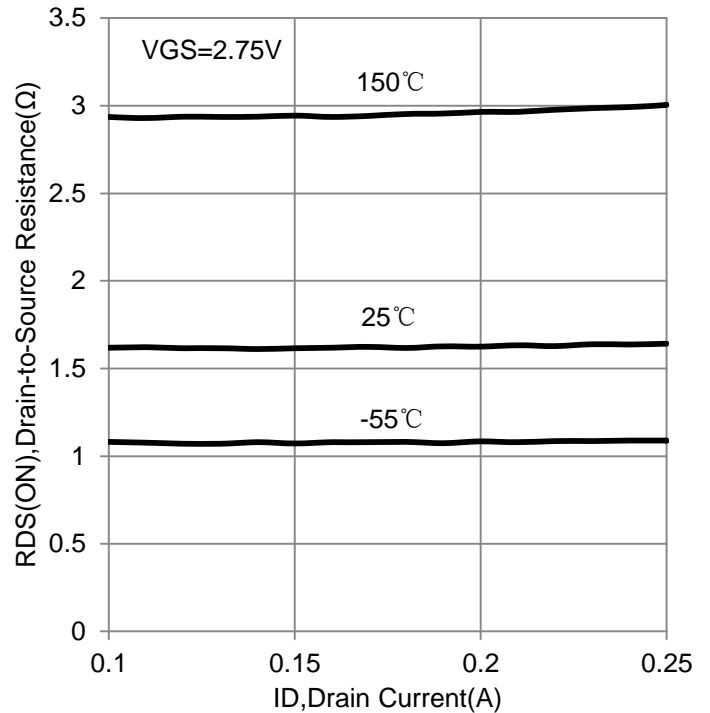

$R_{DS(on)}$ vs. I_D

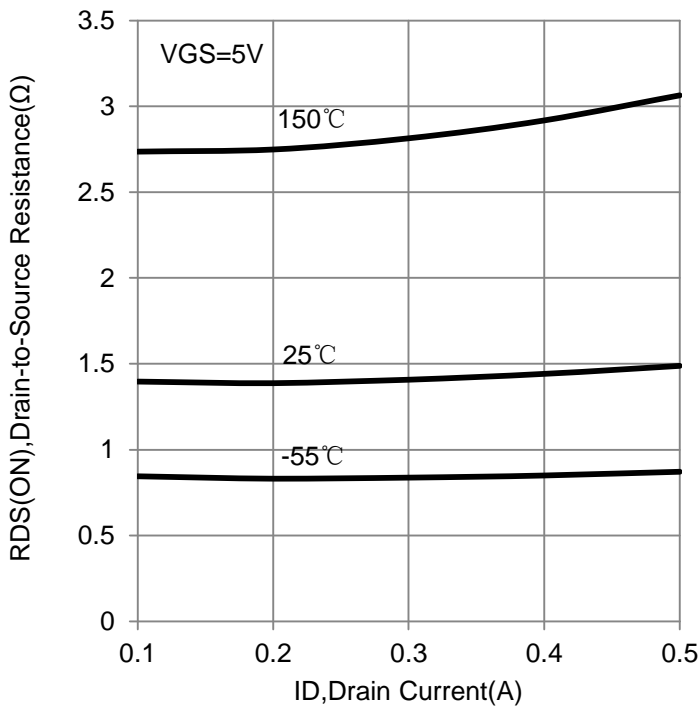

$R_{DS(on)}$ vs. I_D

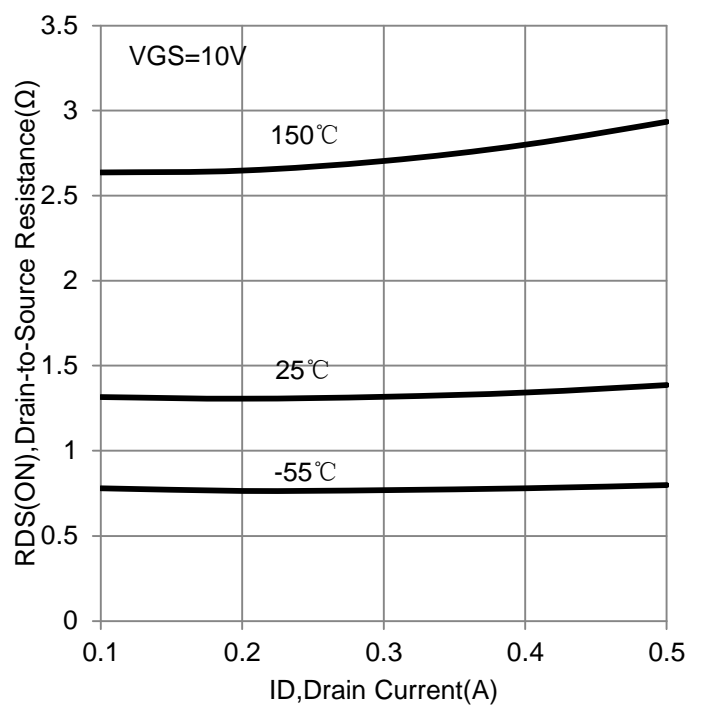

$R_{DS(on)}$ vs. I_D

6.ELECTRICAL CHARACTERISTICS CURVES(Con.)

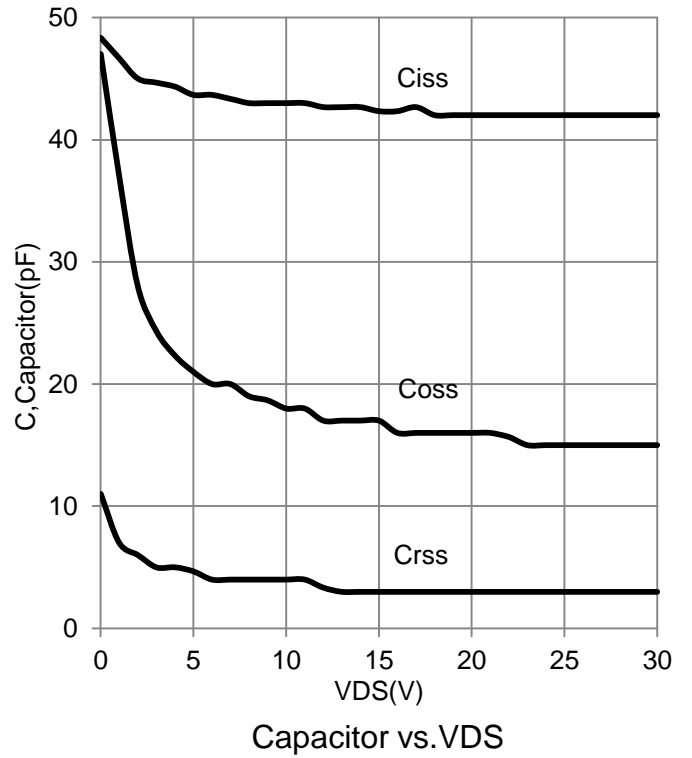
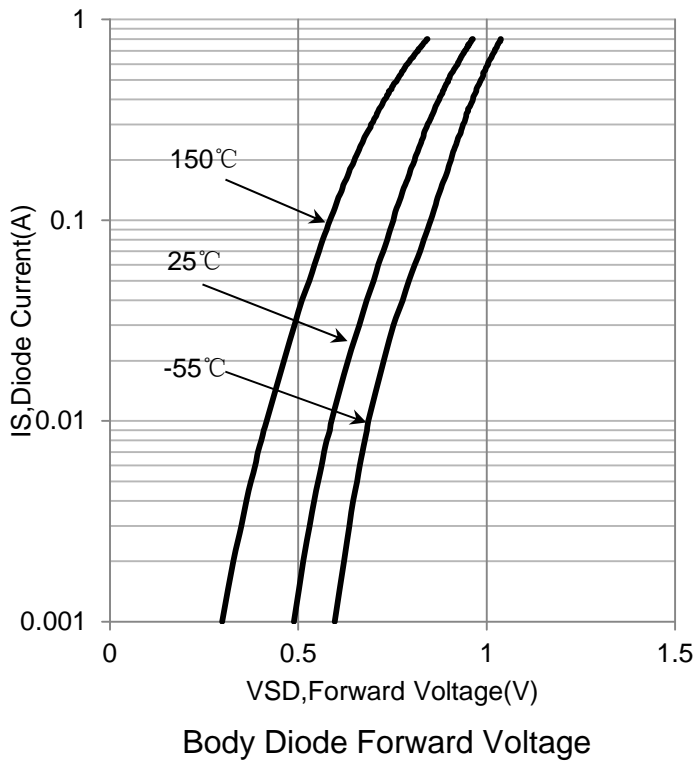

7.OUTLINE AND DIMENSIONS

Notes:

1. DIMENSIONING AND TOLERANCING PER ANSI Y14.5M, 1982.
2. CONTROLLING DIMENSION: MILLIMETERS.
3. MAXIMUM LEAD THICKNESS INCLUDES LEAD FINISH. MINIMUM LEAD THICKNESS IS THE MINIMUM THICKNESS OF BASE MATERIAL.
4. DIMENSIONS D AND E DO NOT INCLUDE MOLD FLASH, PROTRUSIONS OR GATE BURRS.

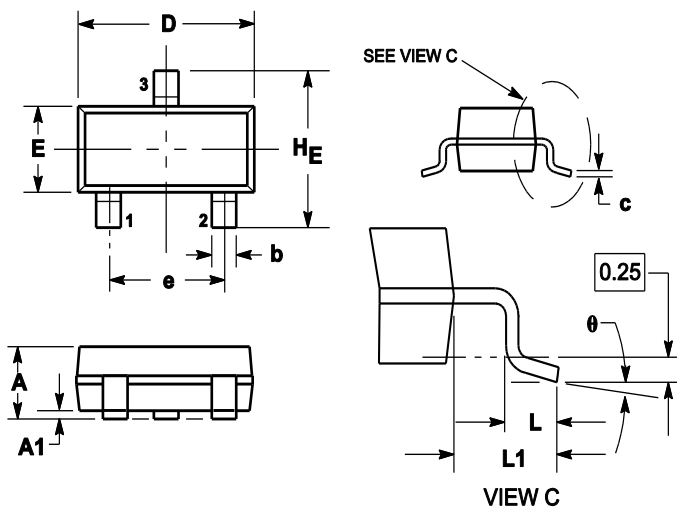

DIM	MILLIMETERS			INCHES		
	MIN	NOM	MAX	MIN	NOM	MAX
A	0.89	1	1.11	0.035	0.04	0.044
A1	0.01	0.06	0.1	0.001	0.002	0.004
b	0.37	0.44	0.5	0.015	0.018	0.02
c	0.09	0.13	0.18	0.003	0.005	0.007
D	2.80	2.9	3.04	0.11	0.114	0.12
E	1.20	1.3	1.4	0.047	0.051	0.055
e	1.78	1.9	2.04	0.07	0.075	0.081
L	0.10	0.2	0.3	0.004	0.008	0.012
L1	0.35	0.54	0.69	0.014	0.021	0.029
HE	2.10	2.4	2.64	0.083	0.094	0.104
theta	0°	---	10°	0°	---	10°

8.SOLDERING FOOTPRINT

